



wasserkraft

TURBINES AND HYDROELECTRIC ENGINEERING

ALL FROM A SINGLE
SOURCE





INNOVATIVE SPIRIT

- | At WWS Wasserkraft GmbH, we combine a high level of technical know-how with an innovative spirit. Here, man and machine together produce the most modern hydroelectric power plant technology.
- | In addition to the highly efficient turbines, WWS Wasserkraft offers all key-components for hydropower stations such as hydraulic power units, turbine control systems, electrical switchgears and all necessary hydraulic steel structures.
- | All these services allow us to offer the best technical and economical solution for each of our clients' projects, whether it is a new power plant or a revitalisation.

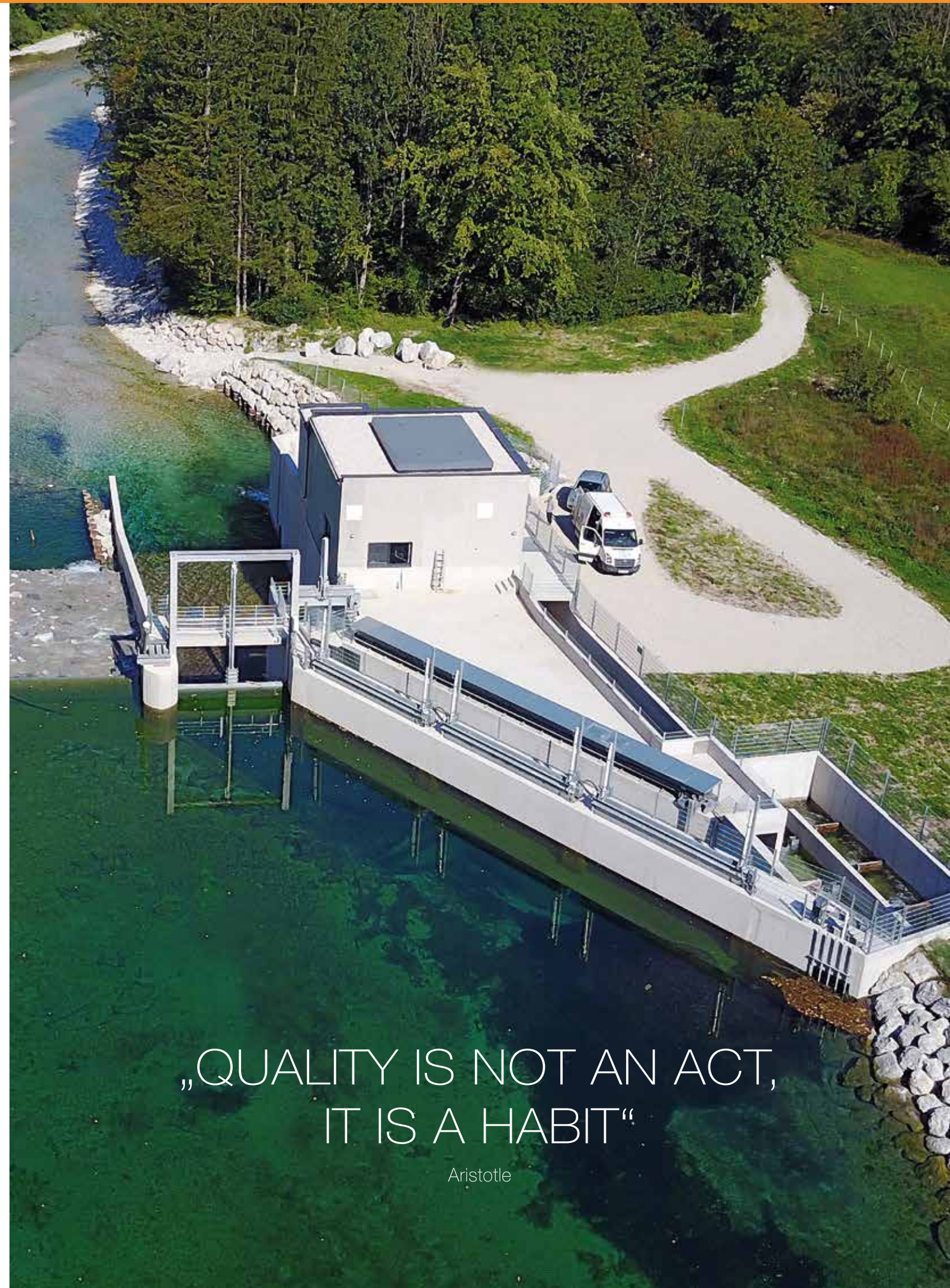

„QUALITY IS NOT AN ACT,
IT IS A HABIT“

Aristotle

HISTORICALLY COMMITTED TO HYDROPOWER

- WWS Wasserkraft is located in the charming small town Neufelden along the river called "Große Mühle", where hydropower is already utilized since more than 200 years.
- We operate our own small hydropower plant which provides reliable green energy for the entire company.
- Due to our history and long-standing experience doing maintenance and refurbishments on our own plants, WWS Wasserkraft is nowadays a global player for small hydroelectrical turbines from 100 kW up to 10 MW output per unit.



LATEST HYDROPOWER TECHNOLOGY

- TAILOR-MADE SOLUTIONS**
WWS Wasserkraft uses its solid knowledge to fulfil all requirements of our customers.
- MADE IN AUSTRIA**
We design, produce and assemble the key-components for your hydropower plant at our own factory in Neufelden, Austria.



EFFICIENCY AT ITS VERY BEST PELTON TURBINE

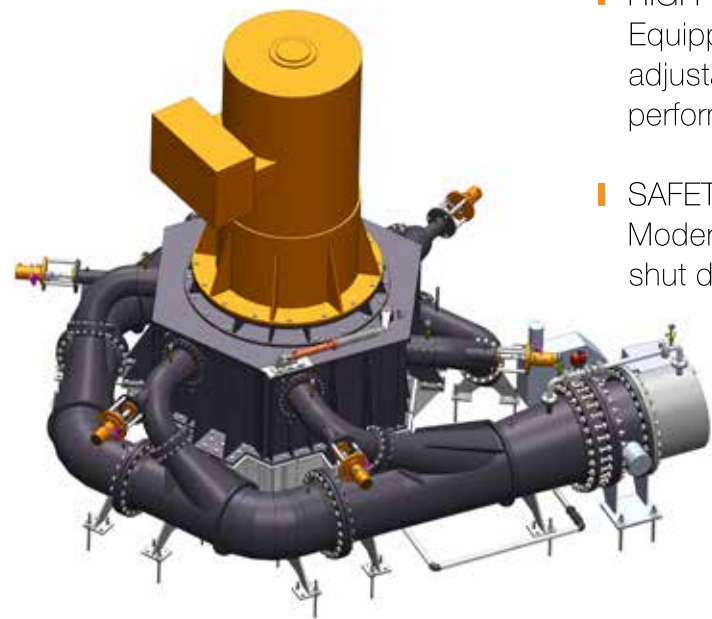

- | **HIGH-PERFORMANCE**
 Equipped with 1-6 injectors which are all individually adjustable, WWS Pelton turbines ensure best performance during maximum and minimum flow rates.
- | **SAFETY**
 Modern security systems guarantee a safe turbine shut down even without electrical power.



SOLID AND DURABLE FRANCIS TURBINE

- | **LONG LIFETIME**
 For highest loadability over many years – our turbine runners are milled out of one single forged disc.
- | **EASY MAINTENANCE**
 Reliable WWS engineering simplifies turbine maintenance.

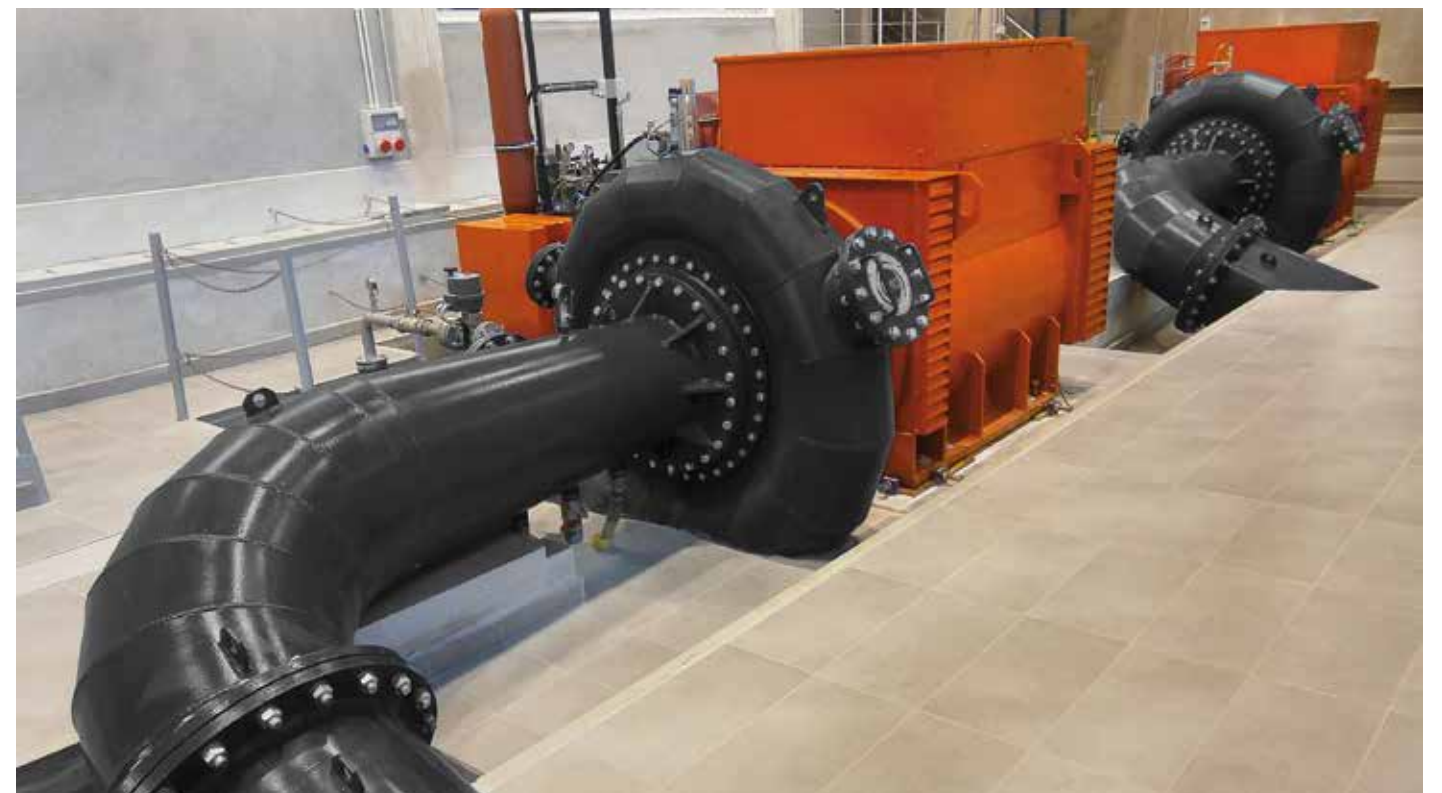
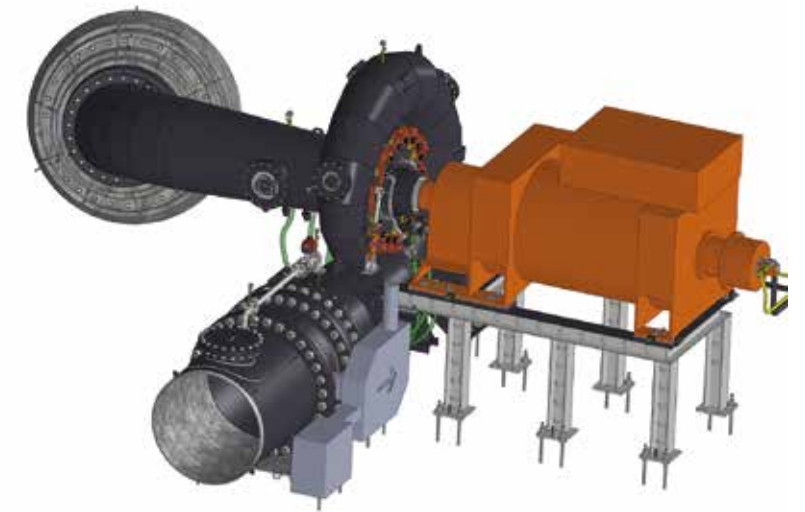

THE FLEXIBLE ONE KAPLAN TURBINE



- | **VERSATILE**
 Various different turbine geometries guarantee a wide range of operation possibilities – from 2 meter to 40 meter head.
- | **EFFICIENT**
 Double regulation of the turbine and a customized blade geometry ensure best return of investment.



RELIABLE AND TRUSTWORTHY IN-HOUSE DESIGN AND DEVELOPMENT

- | **SIMULATIONS**
 In cooperation with the technical University of Graz, we use latest state-of-the-art technology for further development of our turbines.
- | **MODERN TECHNOLOGY**
 Highly skilled engineers are designing each part of the turbine on modern CAD programs.
- | **PROFESSIONAL EXECUTION**
 WWS customers benefit from the strict compliance of national standards and the company's internal quality control systems.

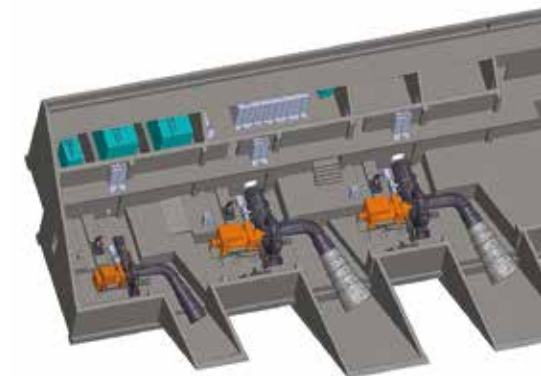
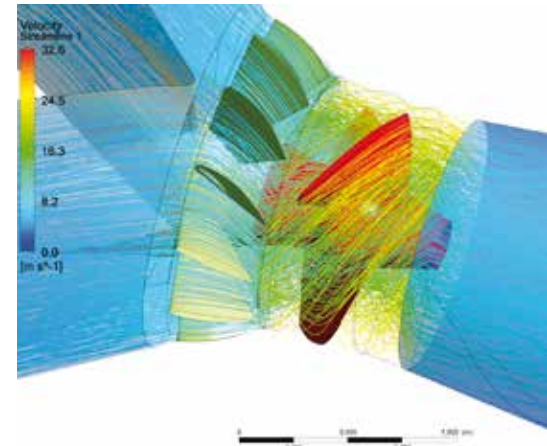

FROM WATER TO WIRE TURNKEY PROJECTS DELIVERED BY WWS WASSERKRAFT

EASY AND SECURE REMOTE CONTROL FROM YOUR SMARTPHONE, TABLET OR PC



Power house design, hydraulic steel components, inlet valve, turbine, generator, hydraulic power unit, SCADA System, electrical switch gear, transformer – our experienced team customize the equipment and support you during the whole project.

With the WWS turbine control system it is possible to operate your hydro power plant secure and comfortable – no matter where you are!

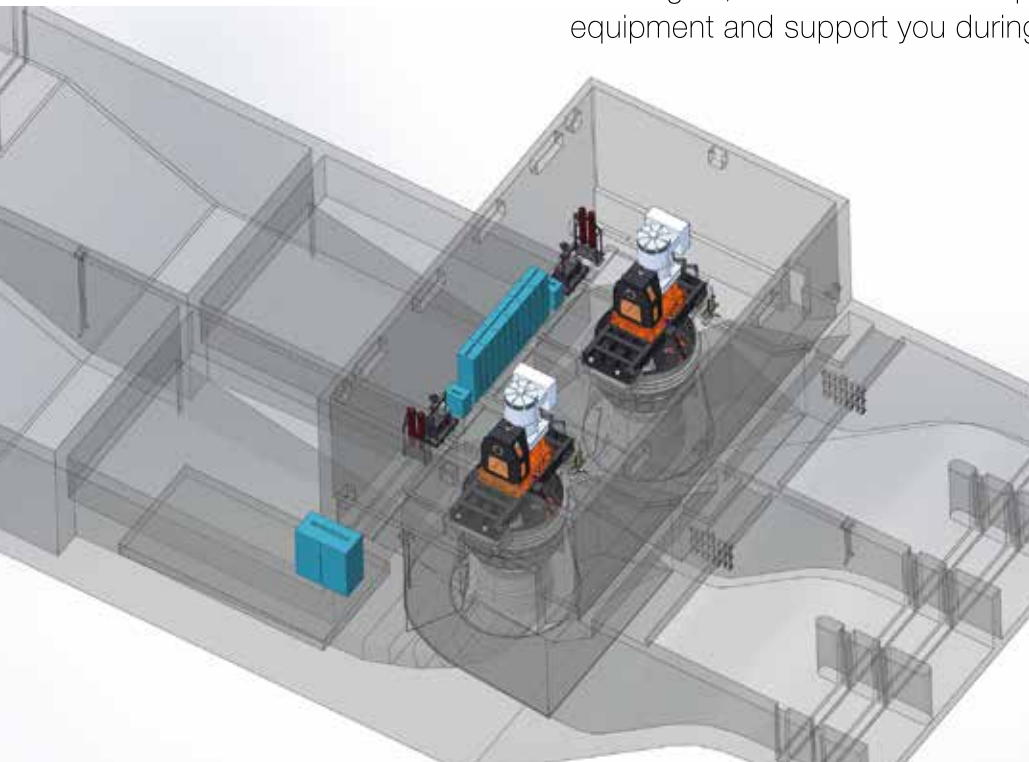

At WWS Wasserkraft, a team of professional technicians is available for your questions. Telephone support and advice as well as preventive maintenance on site are part of our customer service.

FROM AUSTRIA INTO THE WORLD



Austria

INSTALLATION AND COMMISSIONING
WWS Wasserkraft installs turbines with its own highly trained employees. This ensures a smooth completion of your project.



Northern America



Turkey



Austria



Albania



Chile



Indonesia



Albania



Argentina



Romania

VISIT WWS WASSERKRAFT AND THEIR EMPLOYEES



TAKE SOME NOTES

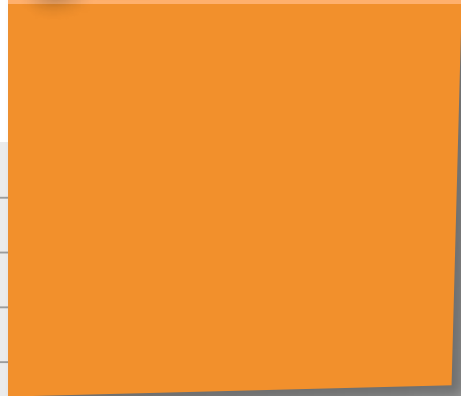

A large area with horizontal lines for taking notes.



wasserkraft

HIGH QUALITY TURBINES

MADE IN AUSTRIA

WWS Wasserkraft GmbH
Oberfeuchtenbach 11
A-4120 Neufelden
Telefon +43 7282 5922
Fax +43 7282 5922 21
office@wvs-wasserkraft.at
www.wvs-wasserkraft.at